

Varenummer: 204360M16150D3U

Beskrivelse: E+G Justerfod  
GN 43-60-M16-150-D3-U

Note: U Uden møtrik, sekskant i toppen, spændeflade i bunden

## Mål

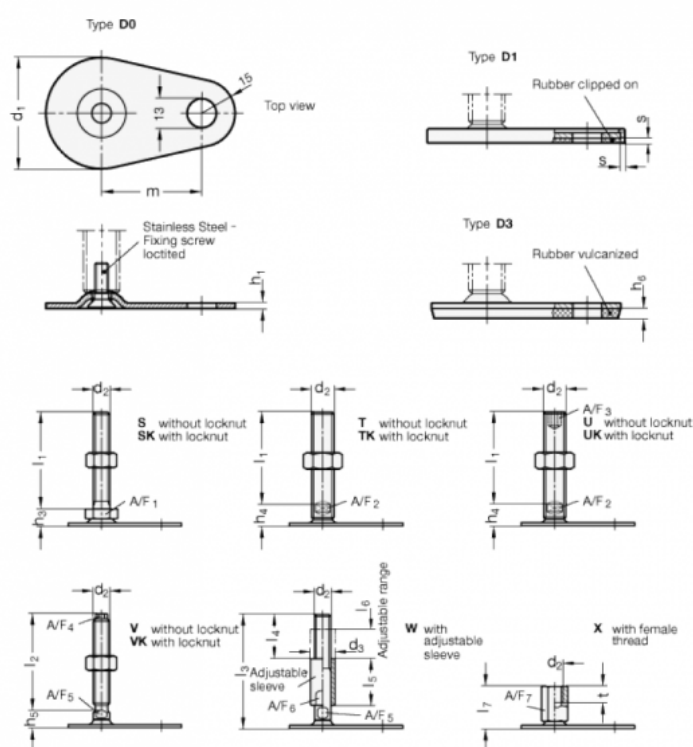

A/F2 = 12	m = 50
A/F3 = 8	s =
d1 = 60	
d2 = M16	
h1 = 2.5	
h4 = 17	
h6 = 4.5	
l1 = 150	